

# Suspended luminaires

## COLLECTION CPL



- Lighting technology LED (optionally available with E27 socket)
- Suspended luminaire (one lamp) with lamp shade (cubical and conical) in different surface finishes
- Transparent wire
- With integral reflector FL or WFL
- Supply unit included
- Connection data: 220-240 V, 50/60 Hz
- Connection to power supply by Wieland plug GST18i3; wire length  $l = 0.5$  m
- Weight approx. 1.8 kg with lamp shade
- Colours: white/antracite/silver

ERC  IP20

with ceiling box

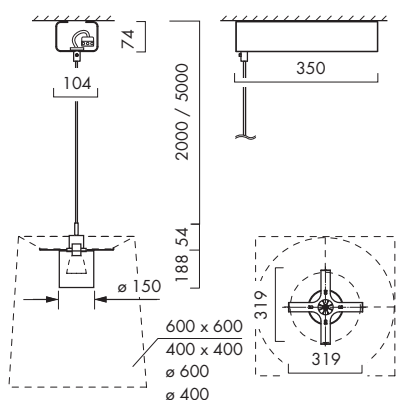

with with 3-circuit adapter and ceiling

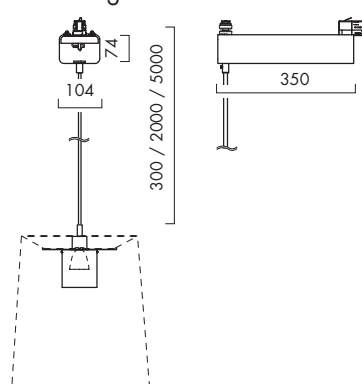

with ceiling plate

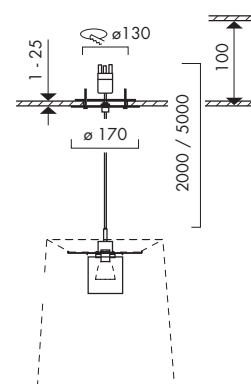

Photometric data	CRI Light colour	Lumen category	P <sub>system</sub>	Efficiency	Reflector
	830	3000 lm	<b>26 W</b>	119 lm/W	FL WFL
		4000 lm	<b>36 W</b>	114 lm/W	
	840 927 Brilliant (930) = Best Color/Best White	Photometric data on request			



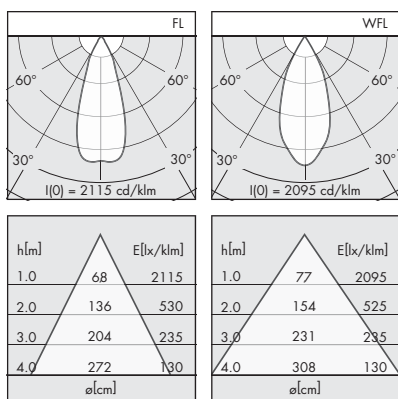













The photometric values are standard values and refer to the entire luminaire. In the case of CRI  $\geq 90$  the efficiency is approx. 10-15 % lower.



For lamp shade versions see page 135 - 136.

# Suspended luminaires



















## LAMP SHADES COLLECTION

		400x400/h= 435	600x600/h= 650	ø 400/h= 435	ø 600/h= 650
					
	Kim night	<b>17 SC 0140</b>	<b>17 SC 0240</b>	<b>17 SC 0340</b>	<b>17 SC 0440</b>
	Kim day	<b>17 SC 0141</b>	<b>17 SC 0241</b>	<b>17 SC 0341</b>	<b>17 SC 0441</b>
	Kim plum	<b>17 SC 0142</b>	<b>17 SC 0242</b>	<b>17 SC 0342</b>	<b>17 SC 0442</b>
	Kim ocean	<b>17 SC 0143</b>	<b>17 SC 0243</b>	<b>17 SC 0343</b>	<b>17 SC 0443</b>
	Kim forrest	<b>17 SC 0144</b>	<b>17 SC 0244</b>	<b>17 SC 0344</b>	<b>17 SC 0444</b>
	Kim clay	<b>17 SC 0145</b>	<b>17 SC 0245</b>	<b>17 SC 0345</b>	<b>17 SC 0445</b>
	Kim grass	<b>17 SC 0146</b>	<b>17 SC 0246</b>	<b>17 SC 0346</b>	<b>17 SC 0446</b>
	Chintz night	<b>17 SC 0110</b>	<b>17 SC 0210</b>	<b>17 SC 0310</b>	<b>17 SC 0410</b>
	Chintz day	<b>17 SC 0131</b>	<b>17 SC 0231</b>	<b>17 SC 0331</b>	<b>17 SC 0431</b>
	Chintz pepper	<b>17 SC 0130</b>	<b>17 SC 0230</b>	<b>17 SC 0330</b>	<b>17 SC 0430</b>
	Chintz chocolate	<b>17 SC 0132</b>	<b>17 SC 0232</b>	<b>17 SC 0332</b>	<b>17 SC 0432</b>
	Chintz nougat	<b>17 SC 0137</b>	<b>17 SC 0237</b>	<b>17 SC 0337</b>	<b>17 SC 0437</b>
	Chintz cappuccino	<b>17 SC 0138</b>	<b>17 SC 0238</b>	<b>17 SC 0338</b>	<b>17 SC 0438</b>
	Chintz grape	<b>17 SC 0139</b>	<b>17 SC 0239</b>	<b>17 SC 0339</b>	<b>17 SC 0439</b>
	Rouge (transparent)	<b>17 SC 0161</b>	<b>17 SC 0261</b>	<b>17 SC 0361</b>	<b>17 SC 0461</b>

The colours of the printed images may differ from those of the originals.

# Suspended luminaires

## LAMP SHADES COLLECTION

		400x400/h= 435 	600x600/h= 650 	ø 400/h= 435 	ø 600/h= 650 
	Smoke (transparent)	<b>17 SC 0162</b>	<b>17 SC 0262</b>	<b>17 SC 0362</b>	<b>17 SC 0462</b>
	Aluminium silver	<b>17 SC 0158</b>	<b>17 SC 0258</b>	<b>17 SC 0358</b>	<b>17 SC 0458</b>
	Aluminium gold	<b>17 SC 0159</b>	<b>17 SC 0259</b>	<b>17 SC 0359</b>	<b>17 SC 0459</b>
	Mirror	<b>17 SC 0160</b>	<b>17 SC 0260</b>	<b>17 SC 0360</b>	<b>17 SC 0460</b>
	Kraft	<b>17 SC 0107</b>	<b>17 SC 0207</b>	<b>17 SC 0307</b>	<b>17 SC 0407</b>
	Lombok ash	<b>17 SC 0154</b>	<b>17 SC 0254</b>	<b>17 SC 0354</b>	<b>17 SC 0454</b>
	Lombok walnut	<b>17 SC 0155</b>	<b>17 SC 0255</b>	<b>17 SC 0355</b>	<b>17 SC 0455</b>
	Palma day	<b>17 SC 0150</b>	<b>17 SC 0250</b>	<b>17 SC 0350</b>	<b>17 SC 0450</b>
	Palma night	<b>17 SC 0153</b>	<b>17 SC 0253</b>	<b>17 SC 0353</b>	<b>17 SC 0453</b>
	Palma stone	<b>17 SC 0151</b>	<b>17 SC 0251</b>	<b>17 SC 0351</b>	<b>17 SC 0451</b>
	Palma sand	<b>17 SC 0152</b>	<b>17 SC 0252</b>	<b>17 SC 0352</b>	<b>17 SC 0452</b>
	Dahlia (translucent)	<b>17 SC 0100</b>	<b>17 SC 0200</b>	<b>17 SC 0300</b>	<b>17 SC 0400</b>
	Barcode (translucent)	<b>17 SC 0109</b>	<b>17 SC 0209</b>	<b>17 SC 0309</b>	<b>17 SC 0409</b>
	Space silver (transparent)	<b>17 SC 0156</b>	<b>17 SC 0256</b>	<b>17 SC 0356</b>	<b>17 SC 0456</b>
	Space gold (transparent)	<b>17 SC 0157</b>	<b>17 SC 0257</b>	<b>17 SC 0357</b>	<b>17 SC 0457</b>

The colours of the printed images may differ from those of the originals.