

GLOBAL Track XTSC - 6300

A three - phase track for control systems
L1/L2/L3/neutral/ground 16 A/400 V + control 3 x 1 A/50 V FELV AC
DALI (FELV), DMX, LON, EIB, 1–10 V etc. compatible.

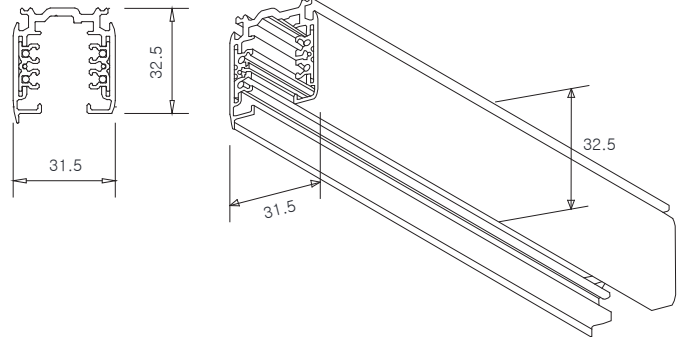

[End feed] XTSC 611 / 612

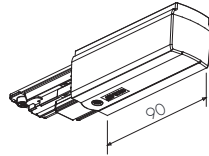

[X - feed] XTSC 638

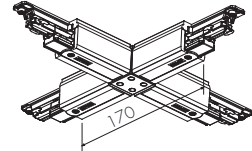

[Middle feed] XTSC 614

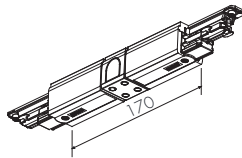

[T - feed] XTSC 636 / 637 / 639 / 640

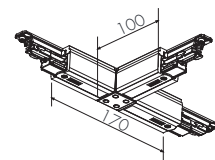

[Straight connector] XTSC 621

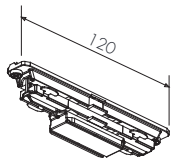

[End cap] XTS 41

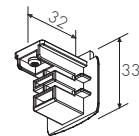

[Flexible corner connector] XTSC 623

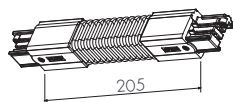

[Cover strip] XTSP 11

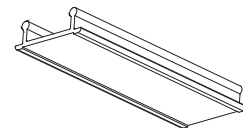

[L - feed] XTSC 634 / 635

